

zg2

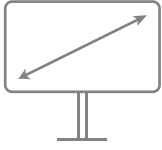

zgonic



Monitor Size Supportable

17" - 38"

(Monitor size for reference only; Weight supportable should be key factor)

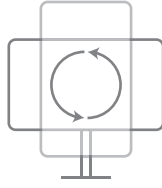

Monitor Pivot Range

360°



Monitor Weight Supportable

**3 - 11kg
(6.6 - 24.2lbs)**



VESA Compliance

**75mm²
& 100mm²**

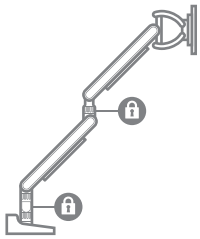

Arm Swivel Range (CW/CCW)²

180° / 360°

(With 180° lock-out feature to protect walls and screens)

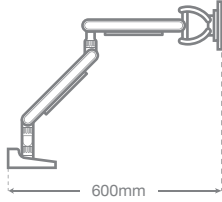

**Extended Arm Reach
(From Desk Edge)**

600mm

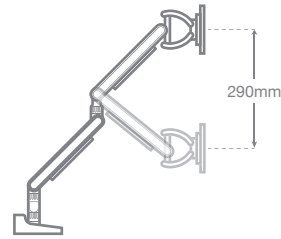

Vertical Arm Adjustment Range

290mm

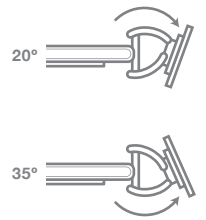

Monitor Tilt Range

**Forward 20°
& Backward 35°**

Quick Release for VESA Attachment :

For ease of monitor replacement

Quick Release for Mounting Attachment :

For ease of transition to crossbar mounting

Warranty Period :

Limited 10 years

Sustainability :

29% recycled and 99% recyclable content

Cable Management :

Semi concealed within upper and lower arm

TYPES OF CLAMPS

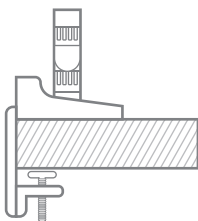

2-PIECE CLAMP

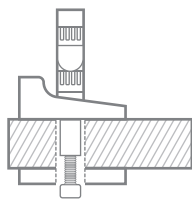

BOLT THRU CLAMP

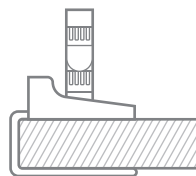

TOP DOWN CLAMP

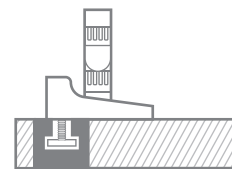

UNIVERSAL RAIL



BODY COLOURS

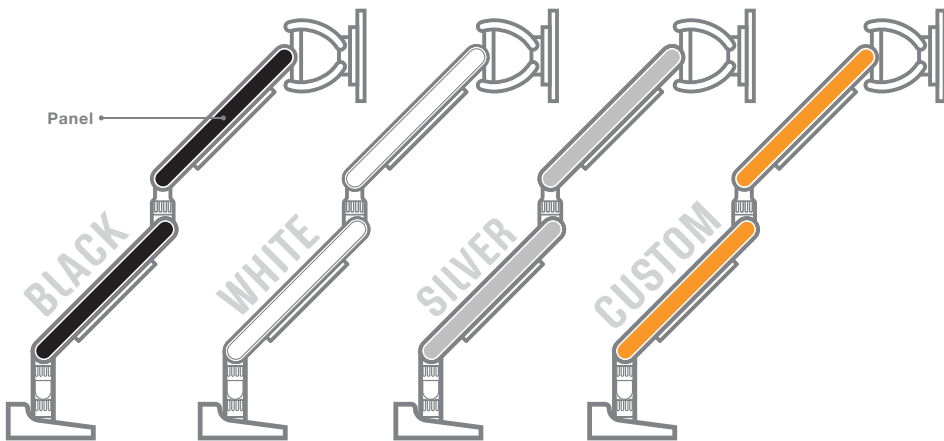
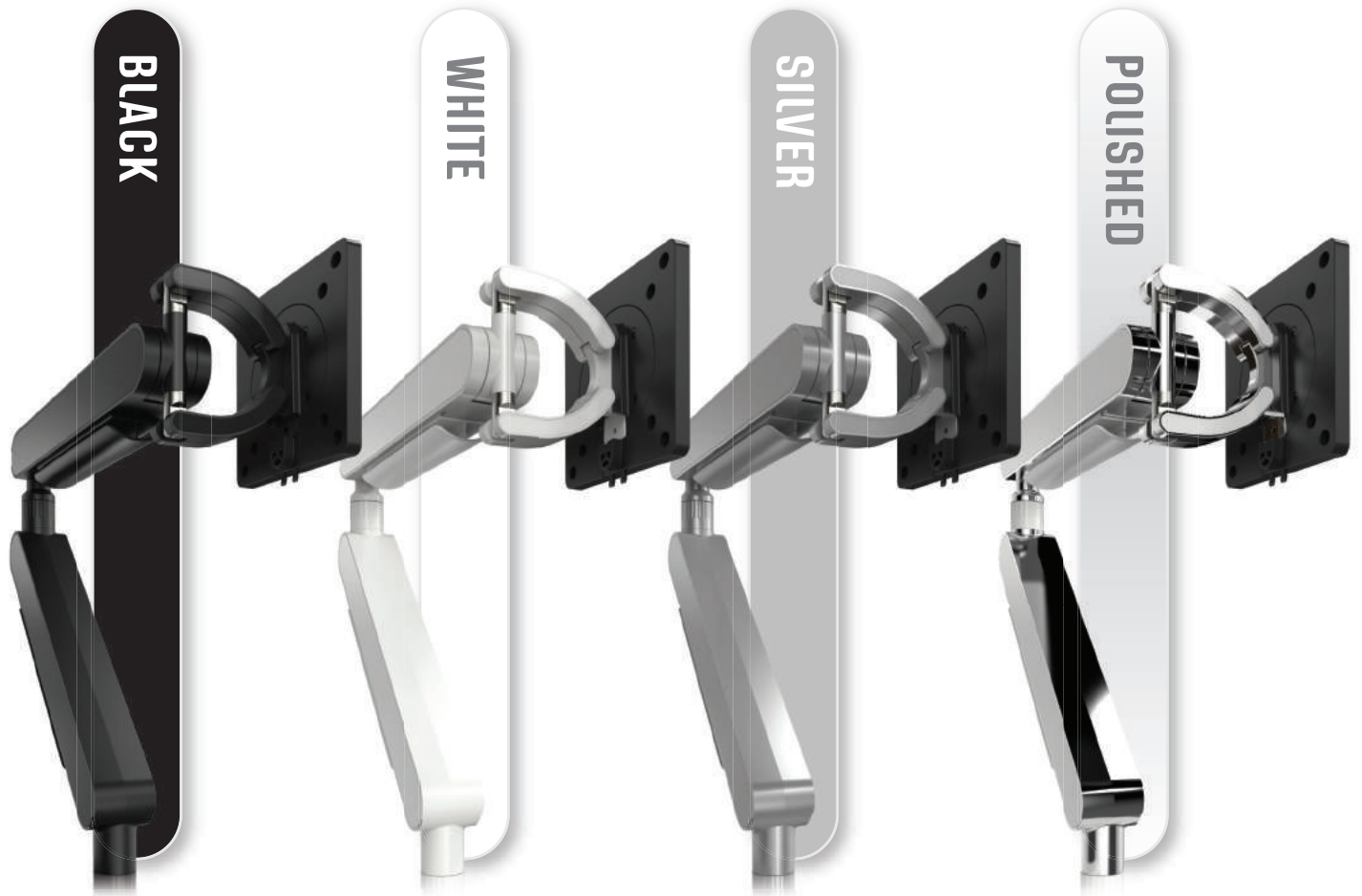

MAGNETIC PANELS

- Black**
 - White**
 - Silver**
 - Custom**
- Create your own colour or design

